

Frequency Synthesizer

DSN-2036A-119+

50Ω 924 to 2036 MHz

The Big Deal

- Fractional N synthesizer
- Low phase noise and spurious
- Wide bandwidth

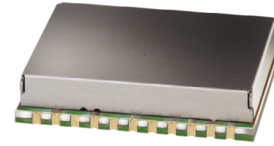

CASE STYLE: KL1294

Product Overview

The DSN-2036A-119+ is a Frequency Synthesizer, designed to operate from 924 to 2036 MHz for Digital TV distribution application. The DSN-2036A-119+ is packaged in a metal case (size of 1.250" x 1.000" x 0.232") to shield against unwanted signals and noise.

Key Features

Feature	Advantages
Low phase noise and spurious: <ul style="list-style-type: none">• Phase Noise: -97 dBc/Hz typ. @ 10 kHz offset• Step Size Spurious: -70 dBc typ.• Comparison Spurious: -85 dBc typ.• Reference Spurious: -85 dBc typ.	Low phase noise and spurious improve system EVM (Error Vector Magnitude).
Robust design and construction	To enhance the robustness of DSN-2036A-119+, each internal component is secured to the substrate with chip bonder, thereby eliminating the risk of tombstoning during subsequent solder reflow operations by the customer.



IF/RF MICROWAVE COMPONENTS • ISO 9001 ISO 14001 AS9100 CERTIFIED RoHS compliant
P.O. Box 350166, Brooklyn, New York 11235-0003 (718) 934-4500 Fax (718) 332-4661



The Design Engineers Search Engine finds the model you need, Instantly • For detailed performance specs & shopping online see



Notes: 1. Performance and quality attributes and conditions not expressly stated in this specification sheet are intended to be excluded and do not form a part of this specification sheet. 2. Electrical specifications and performance data contained herein are based on Mini-Circuit's applicable established test performance criteria and measurement instructions. 3. The parts covered by this specification sheet are subject to Mini-Circuits standard limited warranty and terms and conditions (collectively, "Standard Terms"); Purchasers of this part are entitled to the rights and benefits contained therein. For a full statement of the Standard Terms and the exclusive rights and remedies thereunder, please visit Mini-Circuits' website at www.minicircuits.com/MCLStore/terms.jsp.

Electrical Specifications (over operating temperature -20°C to +70°C)

Parameters	Test Conditions	Min.	Typ.	Max.	Units
Frequency Range	-	924	-	2036	MHz
Step Size	-	-	250	-	kHz
Comparison Frequency	-	-	20	-	MHz
Settling Time	Within ± 1 kHz	-	10	-	mSec
Output Power	-	-1.5	+1.5	+4.5	dBm
SSB Phase Noise	@ 100 Hz offset	-	-80	-	dBc/Hz
	@ 1 kHz offset	-	-100	-92	
	@ 10 kHz offset	-	-97	-91	
	@ 100 kHz offset	-	-115	-109	
	@ 1 MHz offset	-	-138	-132	
Step Size Spurious Suppression	Step Size 250 kHz	-	-70	-50	dBc
0.5 Step Size Spurious Suppression	0.5 Step Size 125 kHz	-	-70	-50	
Reference Spurious Suppression	Ref. Freq. 10 MHz	-	-85	-70	
Comparison Spurious Suppression	Comp. Freq. 20 MHz	-	-85	-70	
Non - Harmonic Spurious Suppression	-	-	-90	-	
Harmonic Suppression	-	-	-25	-8	
VCO Supply Voltage	+8.0	+7.6	+8.0	+8.4	V
PLL Supply Voltage	+18.0	+17.5	+18.0	+18.5	mA
VCO Supply Current	-	-	51	57	
PLL Supply Current	-	-	23	32	
Reference Input (External)	Frequency	10 (square wave)	-	10	MHz
	Amplitude	1	-	1	V _{P-P}
	Input impedance	-	-	100	KΩ
	Phase Noise @ 1 kHz offset	-	-	-145	dBc/Hz
RF Output port Impedance	-	-	50	-	Ω
Input Logic Level	Input high voltage	-	2.65	-	V
	Input low voltage	-	-	0.65	V
Digital Lock Detect	Locked	-	2.00	-	2.85
	Unlocked	-	-	-	0.40
Frequency Synthesizer PLL	-	ADF4153			
PLL Programming	-	3-wire serial 3.3V CMOS			
Register Map @ 2036 MHz	R0_Register	-	(MSB) 110010100000100000000 (LSB)		
	R1_Register *	-	(MSB) 10X000100000101000001 (LSB)		
	R2_Register *	-	(MSB) 10YZW0100010 (LSB)		
	R3_Register	-	(MSB) 1111000111 (LSB)		

* Refer to Charge Pump Settings

FREQ.LOCK [MHz]	Charge Pump Settings			
	X	Y	Z	W
925.00 - 1070.00	0	0	0	1
1070.25 - 1680.00	0	0	1	0
1680.25 - 1850.00	0	0	1	1
1850.25 - 1966.00	1	1	0	0
1966.25 - 2036.00	1	1	0	1

Absolute Maximum Ratings

Parameters	Ratings
VCO Supply Voltage	9V
PLL Supply Voltage	19V
VCO Supply Voltage to PLL Supply Voltage	N.A
Reference Frequency Voltage	-0.3Vmin, +3.6Vmax
Data, Clock, LE Levels	-0.3Vmin, +3.6Vmax
Operating Temperature	-40°C to +85°C
Storage Temperature	-55°C to +100°C

Permanent damage may occur if any of these limits are exceeded



The Design Engineers Search Engine finds the model you need, Instantly • For detailed performance specs & shopping online see minicircuits.com

Notes: 1. Performance and quality attributes and conditions not expressly stated in this specification sheet are intended to be excluded and do not form a part of this specification sheet. 2. Electrical specifications and performance data contained herein are based on Mini-Circuit's applicable established test performance criteria and measurement instructions. 3. The parts covered by this specification sheet are subject to Mini-Circuits standard limited warranty and terms and conditions (collectively, "Standard Terms"); Purchasers of this part are entitled to the rights and benefits contained therein. For a full statement of the Standard Terms and the exclusive rights and remedies thereunder, please visit Mini-Circuits' website at www.minicircuits.com/MCLStore/terms.jsp.

Typical Performance Data

FREQUENCY (MHz)	POWER OUTPUT (dBm)			VCO CURRENT (mA)			PLL CURENT (mA)		
	-25°C	+25°C	+75°C	-25°C	+25°C	+75°C	-25°C	+25°C	+75°C
	924	1.68	1.63	1.58	49.26	50.22	50.96	20.99	22.74
976	1.43	1.42	1.42	49.28	50.23	50.95	21.12	22.90	24.40
1100	1.31	1.35	1.40	49.53	50.45	51.14	19.47	21.24	22.74
1224	1.37	1.38	1.38	49.68	50.55	51.24	20.97	22.78	24.33
1348	1.44	1.40	1.32	49.85	50.69	51.34	21.43	23.25	24.83
1472	1.48	1.40	1.23	50.00	50.82	51.48	21.48	23.32	24.91
1596	1.61	1.32	1.31	50.14	50.97	51.63	21.10	22.94	24.54
1720	1.56	1.38	1.25	50.33	51.20	51.87	19.45	21.27	22.86
1844	1.52	1.39	1.22	50.25	51.17	51.90	20.98	22.83	24.45
1968	1.32	1.27	1.10	50.36	51.36	52.16	21.69	23.60	25.28
2036	0.86	1.08	0.91	50.22	51.24	52.09	21.36	23.27	24.95

FREQUENCY (MHz)	HARMONICS (dBc)					
	F2			F3		
	-25°C	+25°C	+75°C	-25°C	+25°C	+75°C
924	-12.76	-13.53	-15.64	-17.11	-18.45	-20.62
976	-15.00	-15.53	-17.77	-16.61	-18.01	-20.63
1100	-21.39	-21.48	-21.89	-16.84	-18.24	-20.87
1224	-32.20	-31.25	-28.66	-20.02	-21.55	-24.03
1348	-32.15	-34.27	-37.49	-23.35	-25.47	-28.03
1472	-25.29	-26.79	-29.03	-26.95	-28.91	-31.18
1596	-22.88	-24.17	-26.68	-31.74	-32.49	-33.80
1720	-23.16	-24.65	-28.00	-40.18	-41.32	-41.26
1844	-26.42	-28.03	-29.39	-43.84	-43.31	-42.70
1968	-34.64	-35.72	-35.40	-40.62	-39.55	-39.54
2036	-44.95	-46.24	-44.99	-37.56	-37.76	-37.02



IF/RF MICROWAVE COMPONENTS • ISO 9001 ISO 14001 AS9100 CERTIFIED RoHS compliant
 P.O. Box 350166, Brooklyn, New York 11235-0003 (718) 934-4500 Fax (718) 332-4661



The Design Engineers Search Engine finds the model you need, Instantly • For detailed performance specs & shopping online see



Notes: 1. Performance and quality attributes and conditions not expressly stated in this specification sheet are intended to be excluded and do not form a part of this specification sheet. 2. Electrical specifications and performance data contained herein are based on Mini-Circuit's applicable established test performance criteria and measurement instructions. 3. The parts covered by this specification sheet are subject to Mini-Circuits standard limited warranty and terms and conditions (collectively, "Standard Terms"); Purchasers of this part are entitled to the rights and benefits contained therein. For a full statement of the Standard Terms and the exclusive rights and remedies thereunder, please visit Mini-Circuits' website at www.minicircuits.com/MCLStore/terms.jsp.

FREQUENCY (MHz)	PHASE NOISE (dBc/Hz) @ OFFSETS				
	+25°C				
	100Hz	1kHz	10kHz	100kHz	1MHz
924	-87.41	-103.93	-97.71	-113.42	-137.52
976	-86.46	-102.47	-96.48	-113.67	-136.67
1100	-87.03	-101.56	-98.95	-114.34	-138.39
1224	-86.10	-101.86	-98.60	-115.61	-139.42
1348	-85.80	-100.10	-98.27	-116.38	-140.12
1472	-84.69	-99.50	-97.58	-116.52	-141.30
1596	-84.34	-97.65	-96.77	-116.66	-141.54
1720	-85.08	-96.01	-98.00	-116.36	-141.71
1844	-85.09	-97.18	-96.60	-116.94	-141.72
1968	-84.32	-95.91	-97.97	-116.39	-141.20
2036	-83.66	-96.82	-96.88	-116.88	-140.84

FREQUENCY (MHz)	PHASE NOISE (dBc/Hz) @ OFFSETS				
	-25°C				
	100Hz	1kHz	10kHz	100kHz	1MHz
924	-88.88	-104.60	-98.64	-114.03	-138.60
976	-89.32	-101.55	-97.69	-114.27	-138.40
1100	-87.87	-103.57	-99.78	-114.69	-139.22
1224	-86.92	-101.47	-98.94	-116.21	-140.37
1348	-85.43	-101.65	-99.22	-117.01	-141.24
1472	-85.68	-101.73	-98.45	-117.15	-142.21
1596	-84.23	-99.45	-97.63	-117.34	-142.19
1720	-83.38	-99.14	-98.74	-116.86	-142.08
1844	-82.50	-97.44	-97.39	-117.45	-142.31
1968	-82.45	-96.32	-98.38	-116.80	-141.80
2036	-82.16	-95.37	-97.65	-117.03	-141.50

FREQUENCY (MHz)	PHASE NOISE (dBc/Hz) @ OFFSETS				
	+75°C				
	100Hz	1kHz	10kHz	100kHz	1MHz
924	-90.31	-101.37	-96.83	-112.42	-135.72
976	-88.65	-100.68	-96.37	-112.97	-135.19
1100	-87.65	-101.34	-98.95	-113.58	-136.97
1224	-87.01	-100.77	-98.76	-114.85	-138.51
1348	-86.99	-101.61	-98.56	-115.55	-139.58
1472	-86.55	-98.54	-96.85	-115.62	-140.18
1596	-85.55	-99.32	-96.34	-115.91	-140.47
1720	-83.87	-99.35	-97.07	-115.53	-140.86
1844	-84.55	-96.51	-96.01	-116.36	-140.90
1968	-83.77	-95.47	-96.63	-116.05	-140.36
2036	-82.20	-96.66	-95.11	-116.51	-140.16



IF/RF MICROWAVE COMPONENTS • ISO 9001 ISO 14001 AS9100 CERTIFIED RoHS compliant
 P.O. Box 350166, Brooklyn, New York 11235-0003 (718) 934-4500 Fax (718) 332-4661



The Design Engineers Search Engine finds the model you need, Instantly • For detailed performance specs & shopping online see



Notes: 1. Performance and quality attributes and conditions not expressly stated in this specification sheet are intended to be excluded and do not form a part of this specification sheet. 2. Electrical specifications and performance data contained herein are based on Mini-Circuit's applicable established test performance criteria and measurement instructions. 3. The parts covered by this specification sheet are subject to Mini-Circuits standard limited warranty and terms and conditions (collectively, "Standard Terms"); Purchasers of this part are entitled to the rights and benefits contained therein. For a full statement of the Standard Terms and the exclusive rights and remedies thereunder, please visit Mini-Circuits' website at www.minicircuits.com/MCLStore/terms.jsp.

COMPARISON SPURIOUS ORDER	COMPARISON SPURIOUS @Fcarrier 924MHz+(n*Fcomparison) (dBc) note 1			COMPARISON SPURIOUS @Fcarrier 1492MHz+(n*Fcomparison) (dBc) note 1			COMPARISON SPURIOUS @Fcarrier 2036MHz+(n*Fcomparison) (dBc) note 1		
	n	-25°C	+25°C	+75°C	-25°C	+25°C	+75°C	-25°C	+25°C
-5	-105.04	-95.38	-98.54	-97.78	-92.31	-100.79	-100.19	-90.97	-91.79
-4	-98.44	-92.13	-94.90	-93.59	-95.52	-93.14	-95.46	-92.43	-90.08
-3	-99.04	-90.77	-89.26	-86.65	-95.67	-89.71	-97.73	-90.89	-101.28
-2	-100.08	-91.14	-95.89	-90.95	-94.63	-95.36	-93.38	-90.83	-93.76
-1	-91.29	-92.88	-86.41	-88.07	-96.14	-100.08	-93.58	-87.79	-90.57
0 note 2	-	-	-	-	-	-	-	-	-
+1	-85.60	-84.89	-88.19	-98.01	-99.69	-93.61	-96.89	-95.58	-96.11
+2	-88.21	-88.21	-89.76	-99.85	-96.36	-90.75	-98.31	-94.60	-100.32
+3	-88.99	-87.93	-93.68	-99.10	-98.39	-93.47	-90.77	-96.25	-109.30
+4	-89.96	-101.80	-95.68	-97.23	-97.05	-90.71	-93.01	-94.11	-95.47
+5	-92.73	-102.53	-93.69	-95.61	-106.03	-96.02	-96.25	-95.60	-97.52

Note 1: Comparison frequency 20 MHz
 Note 2: All spurs are referenced to carrier signal (n=0).

REFERENCE SPURIOUS ORDER	REFERENCE SPURIOUS @Fcarrier 924MHz+(n*Freference) (dBc) note 3			REFERENCE SPURIOUS @Fcarrier 1492MHz+(n*Freference) (dBc) note 3			REFERENCE SPURIOUS @Fcarrier 2036MHz+(n*Freference) (dBc) note 3		
	n	-25°C	+25°C	+75°C	-25°C	+25°C	+75°C	-25°C	+25°C
-5	-115.28	-118.59	-110.48	-98.92	-111.95	-101.49	-112.65	-109.74	-110.25
-4	-100.08	-91.14	-95.89	-90.95	-94.63	-95.36	-93.38	-90.83	-93.76
-3	-115.17	-111.32	-115.54	-99.36	-102.56	-115.50	-105.11	-105.34	-110.89
-2	-91.29	-92.88	-86.41	-88.07	-96.14	-100.08	-93.58	-87.79	-90.57
-1	-113.09	-102.27	-111.50	-100.51	-98.99	-99.78	-106.16	-101.05	-108.72
0 note 4	-	-	-	-	-	-	-	-	-
+1	-111.45	-101.41	-112.88	-99.82	-100.96	-101.71	-104.66	-100.15	-108.07
+2	-85.60	-84.89	-88.19	-98.01	-99.69	-93.61	-96.89	-95.58	-96.11
+3	-112.34	-110.10	-110.52	-103.79	-108.56	-99.99	-110.12	-109.35	-109.32
+4	-88.21	-88.21	-89.76	-99.85	-96.36	-90.75	-98.31	-94.60	-100.32
+5	-106.25	-113.72	-111.97	-100.15	-117.66	-102.23	-110.07	-108.76	-109.52

Note 3: Reference frequency 10 MHz
 Note 4: All spurs are referenced to carrier signal (n=0).



IF/RF MICROWAVE COMPONENTS • ISO 9001 ISO 14001 AS9100 CERTIFIED RoHS compliant
 P.O. Box 350166, Brooklyn, New York 11235-0003 (718) 934-4500 Fax (718) 332-4661



The Design Engineers Search Engine finds the model you need, Instantly • For detailed performance specs & shopping online see



Notes: 1. Performance and quality attributes and conditions not expressly stated in this specification sheet are intended to be excluded and do not form a part of this specification sheet. 2. Electrical specifications and performance data contained herein are based on Mini-Circuit's applicable established test performance criteria and measurement instructions. 3. The parts covered by this specification sheet are subject to Mini-Circuits standard limited warranty and terms and conditions (collectively, "Standard Terms"); Purchasers of this part are entitled to the rights and benefits contained therein. For a full statement of the Standard Terms and the exclusive rights and remedies thereunder, please visit Mini-Circuits' website at www.minicircuits.com/MCLStore/terms.jsp.

STEP SIZE SPURIOUS ORDER n	0.5 STEP SIZE & STEP SIZE SPURIOUS @Fcarrier 924MHz+(n*Fstep size) (dBc) note 5			0.5 STEP SIZE & STEP SIZE SPURIOUS @Fcarrier 1492MHz+(n*Fstep size) (dBc) note 5			0.5 STEP SIZE & STEP SIZE SPURIOUS @Fcarrier 2036MHz+(n*Fstep size) (dBc) note 5		
	-25°C	+25°C	+75°C	-25°C	+25°C	+75°C	-25°C	+25°C	+75°C
-5.0	-108.64	-107.52	-108.69	-105.80	-105.52	-111.77	-107.19	-105.42	-103.37
-4.5	-105.43	-100.33	-110.25	-109.10	-102.01	-99.23	-106.01	-115.40	-109.76
-4.0	-108.39	-98.92	-100.40	-108.60	-114.72	-112.42	-103.01	-106.73	-111.36
-3.5	-96.21	-115.01	-101.37	-101.40	-107.43	-100.53	-107.55	-101.58	-102.13
-3.0	-103.26	-101.49	-100.18	-99.95	-113.47	-110.69	-103.33	-103.85	-107.87
-2.5	-93.82	-88.37	-85.90	-99.34	-98.64	-102.86	-93.22	-91.04	-98.25
-2.0	-106.67	-96.50	-90.80	-100.12	-105.50	-101.11	-93.48	-102.14	-100.18
-1.5	-80.55	-84.50	-85.61	-105.29	-99.35	-93.99	-88.18	-88.74	-104.54
-1.0	-89.71	-95.93	-82.94	-84.62	-87.79	-80.69	-76.83	-83.77	-87.86
-0.5	-69.81	-67.18	-73.35	-78.63	-75.07	-70.63	-64.39	-70.17	-68.90
0 note 6	-	-	-	-	-	-	-	-	-
+0.5	-69.80	-67.01	-71.90	-80.91	-74.95	-71.49	-65.28	-68.78	-68.04
+1.0	-91.40	-101.35	-84.81	-83.90	-87.14	-80.79	-77.85	-83.63	-87.62
+1.5	-80.07	-84.81	-85.08	-101.96	-101.40	-92.29	-88.97	-88.13	-102.91
+2.0	-109.10	-96.25	-89.88	-98.74	-108.65	-102.75	-95.42	-106.96	-99.89
+2.5	-95.07	-88.56	-86.32	-102.52	-100.24	-100.83	-92.42	-90.68	-96.82
+3.0	-104.69	-103.24	-99.66	-98.72	-111.01	-109.31	-101.20	-103.22	-107.09
+3.5	-97.35	-116.05	-100.45	-100.58	-106.79	-102.43	-103.01	-101.98	-101.10
+4.0	-113.05	-99.15	-98.99	-106.61	-114.54	-109.94	-103.95	-105.03	-110.02
+4.5	-106.50	-100.14	-110.57	-111.09	-100.82	-100.39	-107.04	-116.32	-112.45
+5.0	-107.66	-109.73	-107.10	-110.23	-103.35	-107.46	-103.05	-104.32	-104.62

Note 5: Step size 250 kHz

Note 6: All spurs are referenced to carrier signal (n=0).



IF/RF MICROWAVE COMPONENTS • ISO 9001 ISO 14001 AS9100 CERTIFIED RoHS compliant
 P.O. Box 350166, Brooklyn, New York 11235-0003 (718) 934-4500 Fax (718) 332-4661



The Design Engineers Search Engine finds the model you need, Instantly • For detailed performance specs & shopping online see



Notes: 1. Performance and quality attributes and conditions not expressly stated in this specification sheet are intended to be excluded and do not form a part of this specification sheet. 2. Electrical specifications and performance data contained herein are based on Mini-Circuit's applicable established test performance criteria and measurement instructions. 3. The parts covered by this specification sheet are subject to Mini-Circuits standard limited warranty and terms and conditions (collectively, "Standard Terms"); Purchasers of this part are entitled to the rights and benefits contained therein. For a full statement of the Standard Terms and the exclusive rights and remedies thereunder, please visit Mini-Circuits' website at www.minicircuits.com/MCLStore/terms.jsp.

Typical Performance Curves

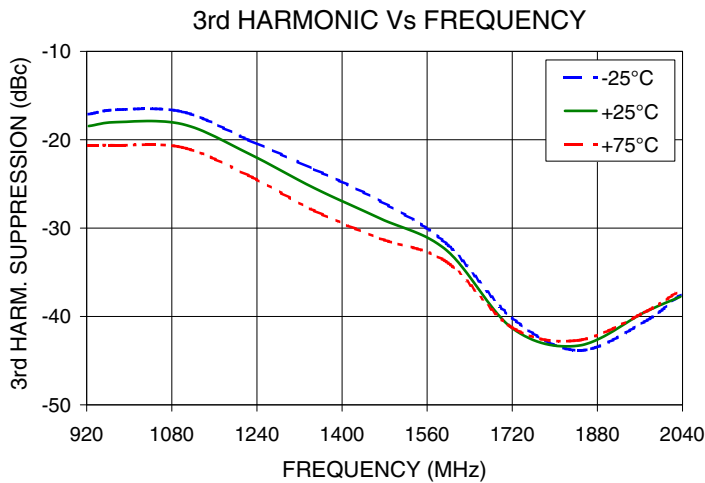
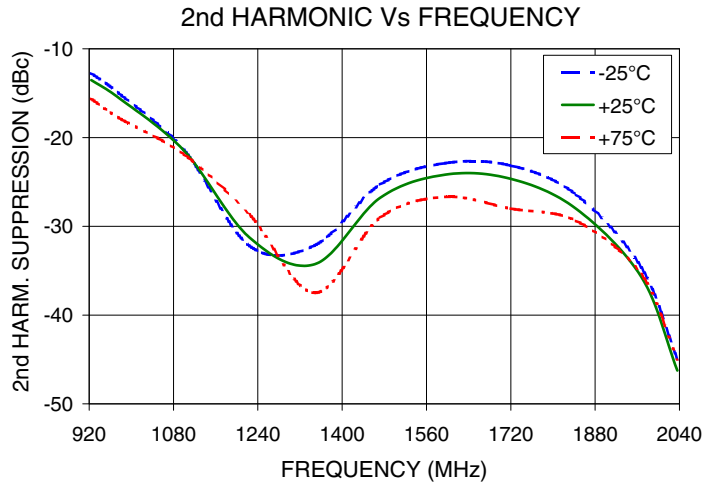
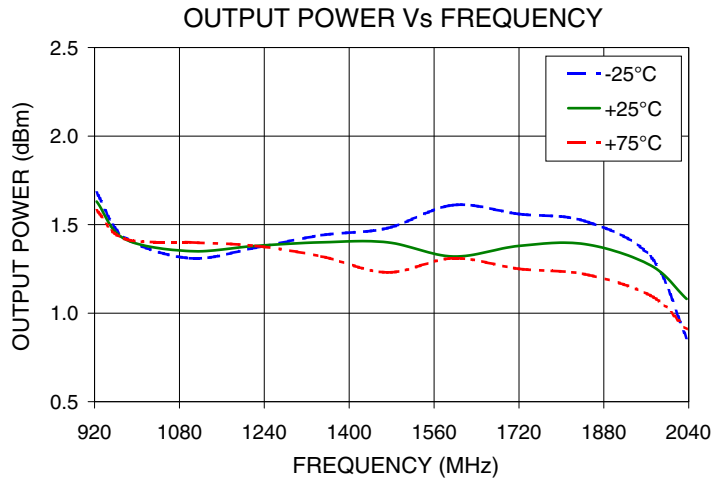

IF/RF MICROWAVE COMPONENTS • ISO 9001 ISO 14001 AS9100 CERTIFIED RoHS compliant
 P.O. Box 350166, Brooklyn, New York 11235-0003 (718) 934-4500 Fax (718) 332-4661



The Design Engineers Search Engine finds the model you need, Instantly • For detailed performance specs & shopping online see



Notes: 1. Performance and quality attributes and conditions not expressly stated in this specification sheet are intended to be excluded and do not form a part of this specification sheet. 2. Electrical specifications and performance data contained herein are based on Mini-Circuit's applicable established test performance criteria and measurement instructions. 3. The parts covered by this specification sheet are subject to Mini-Circuits standard limited warranty and terms and conditions (collectively, "Standard Terms"); Purchasers of this part are entitled to the rights and benefits contained therein. For a full statement of the Standard Terms and the exclusive rights and remedies thereunder, please visit Mini-Circuits' website at www.minicircuits.com/MCLStore/terms.jsp.

PHASE NOISE @ 100Hz offset

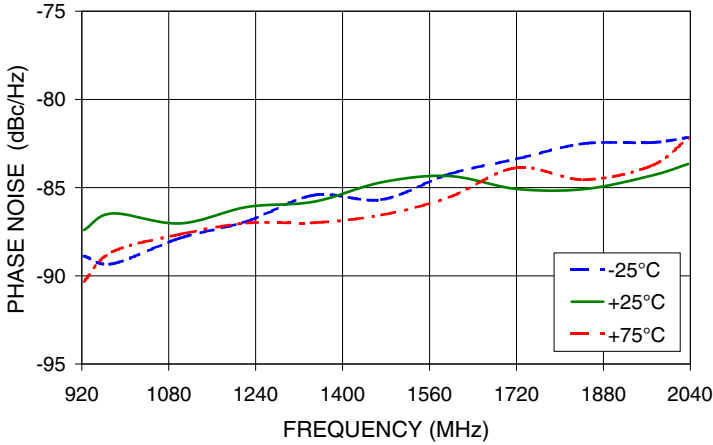

PHASE NOISE @ 1kHz offset

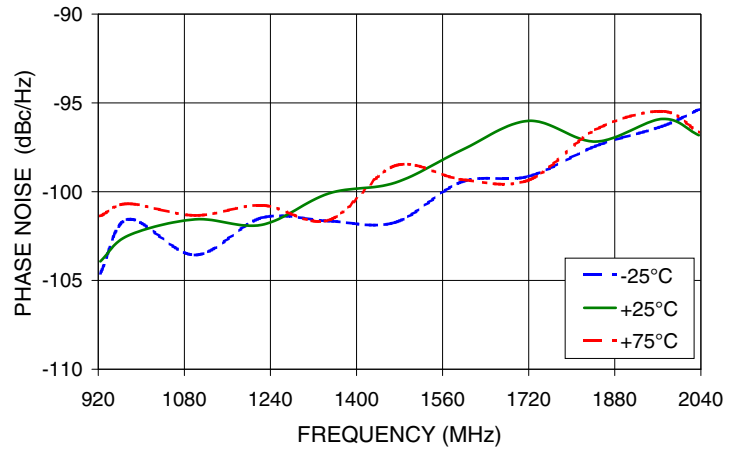

PHASE NOISE @ 10kHz offset

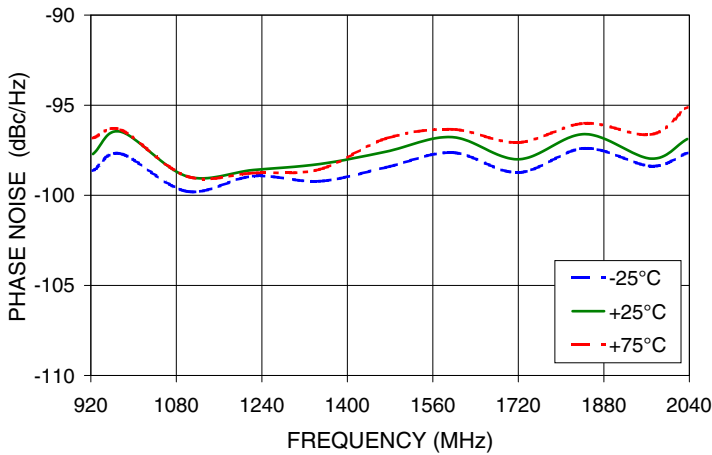

PHASE NOISE @ 100kHz offset

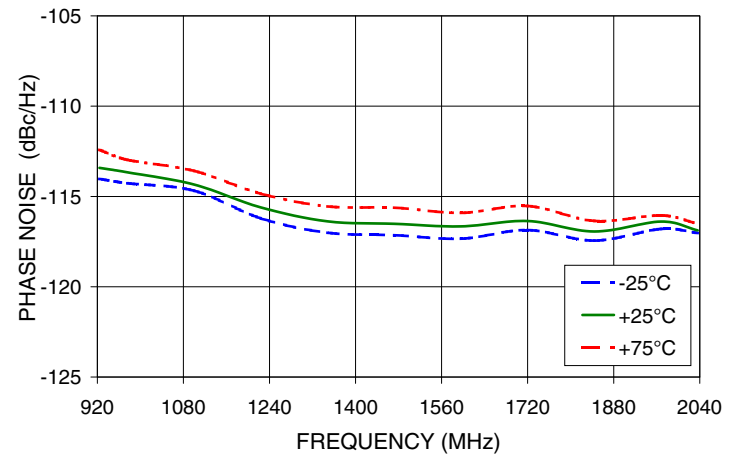

PHASE NOISE @ 1MHz offset

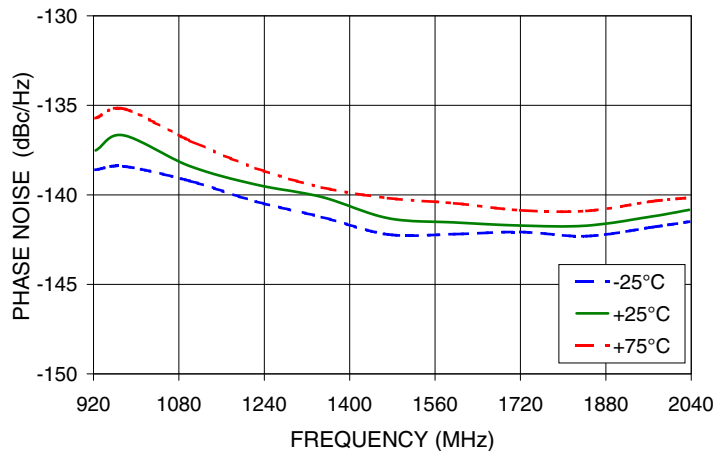

IF/RF MICROWAVE COMPONENTS • ISO 9001 ISO 14001 AS9100 CERTIFIED RoHS compliant
 P.O. Box 350166, Brooklyn, New York 11235-0003 (718) 934-4500 Fax (718) 332-4661



The Design Engineers Search Engine finds the model you need, Instantly • For detailed performance specs & shopping online see



Notes: 1. Performance and quality attributes and conditions not expressly stated in this specification sheet are intended to be excluded and do not form a part of this specification sheet. 2. Electrical specifications and performance data contained herein are based on Mini-Circuit's applicable established test performance criteria and measurement instructions. 3. The parts covered by this specification sheet are subject to Mini-Circuits standard limited warranty and terms and conditions (collectively, "Standard Terms"); Purchasers of this part are entitled to the rights and benefits contained therein. For a full statement of the Standard Terms and the exclusive rights and remedies thereunder, please visit Mini-Circuits' website at www.minicircuits.com/MCLStore/terms.jsp.

COMPARISON SPURIOUS
Vs FREQ. OFFSET @ Fcar = 924MHz

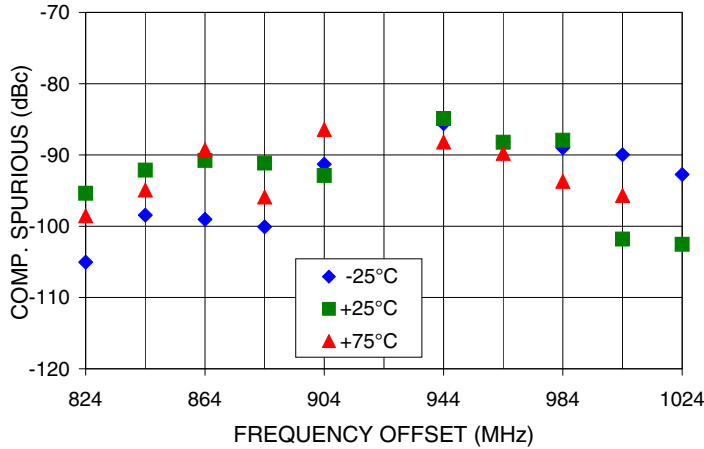

REFERENCE SPURIOUS
Vs FREQ. OFFSET @ Fcar = 924MHz

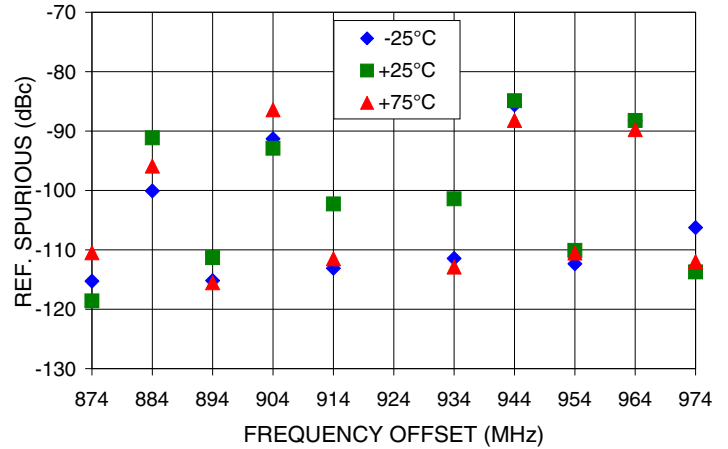

COMPARISON SPURIOUS
Vs FREQ. OFFSET @ Fcar = 1492MHz

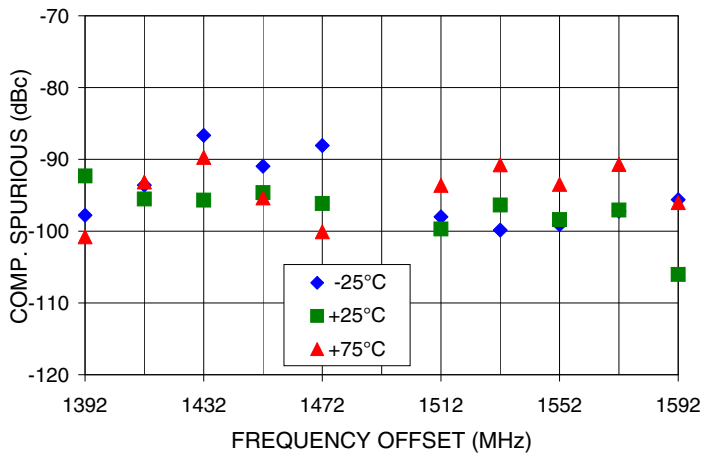

REFERENCE SPURIOUS
Vs FREQ. OFFSET @ Fcar = 1492MHz

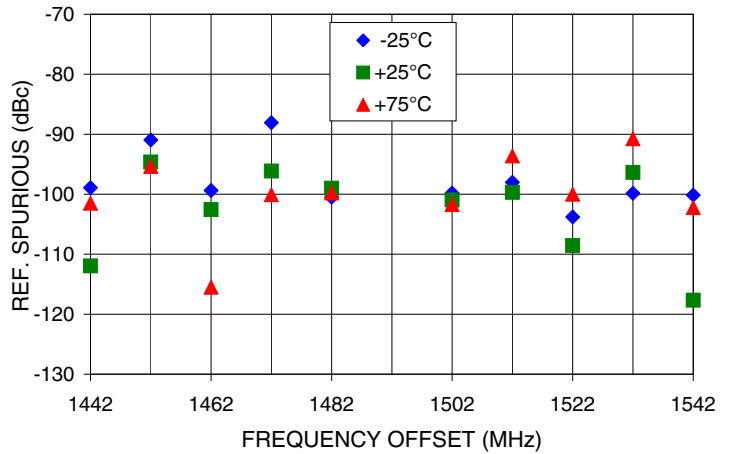

COMPARISON SPURIOUS
Vs FREQ. OFFSET @ Fcar = 2036MHz

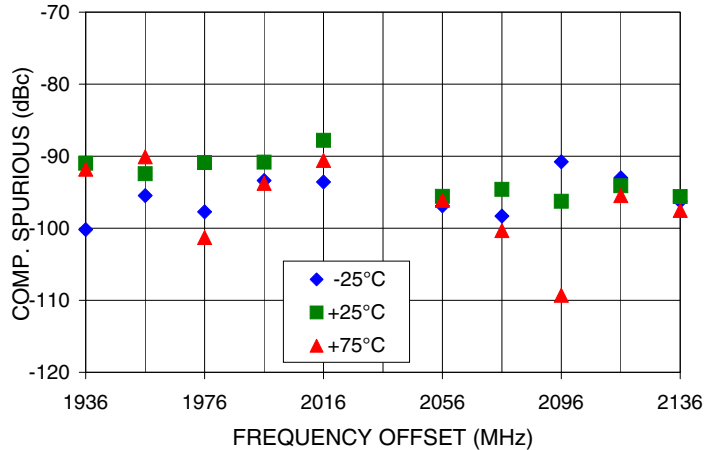

REFERENCE SPURIOUS
Vs FREQ. OFFSET @ Fcar = 2036MHz

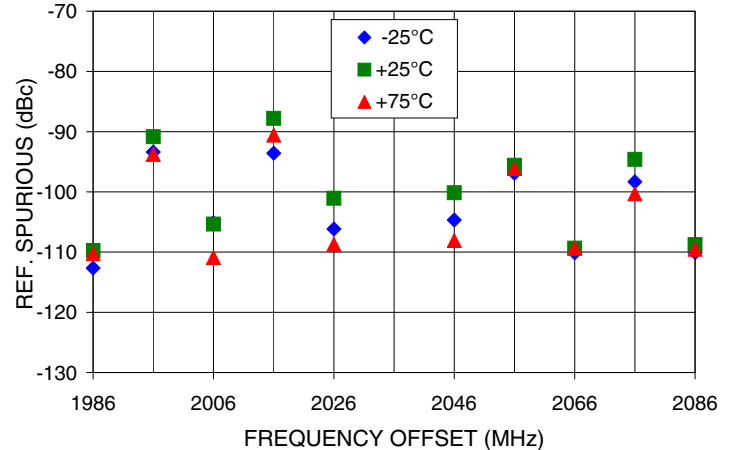

IF/RF MICROWAVE COMPONENTS • ISO 9001 ISO 14001 AS9100 CERTIFIED RoHS compliant
P.O. Box 350166, Brooklyn, New York 11235-0003 (718) 934-4500 Fax (718) 332-4661



The Design Engineers Search Engine finds the model you need, Instantly • For detailed performance specs & shopping online see



Notes: 1. Performance and quality attributes and conditions not expressly stated in this specification sheet are intended to be excluded and do not form a part of this specification sheet. 2. Electrical specifications and performance data contained herein are based on Mini-Circuit's applicable established test performance criteria and measurement instructions. 3. The parts covered by this specification sheet are subject to Mini-Circuits standard limited warranty and terms and conditions (collectively, "Standard Terms"); Purchasers of this part are entitled to the rights and benefits contained therein. For a full statement of the Standard Terms and the exclusive rights and remedies thereunder, please visit Mini-Circuits' website at www.minicircuits.com/MCLStore/terms.jsp.

0.5 STEP SIZE & STEP SIZE SPURIOUS
Vs FREQ. OFFSET @ Fcar = 924MHz

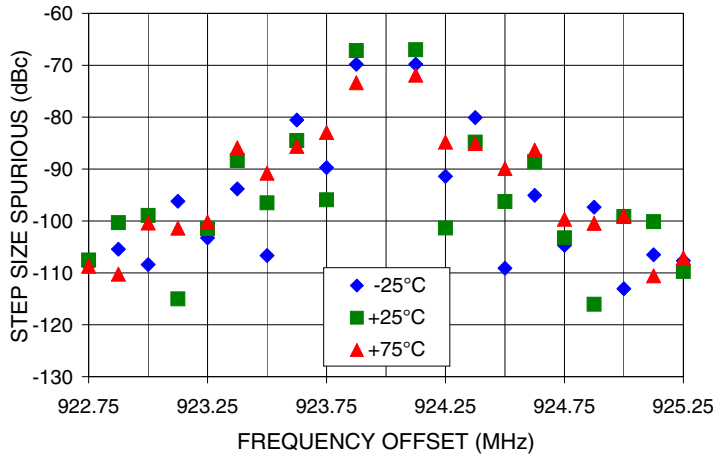

0.5 STEP SIZE & STEP SIZE SPURIOUS
Vs FREQ. OFFSET @ Fcar = 1492MHz

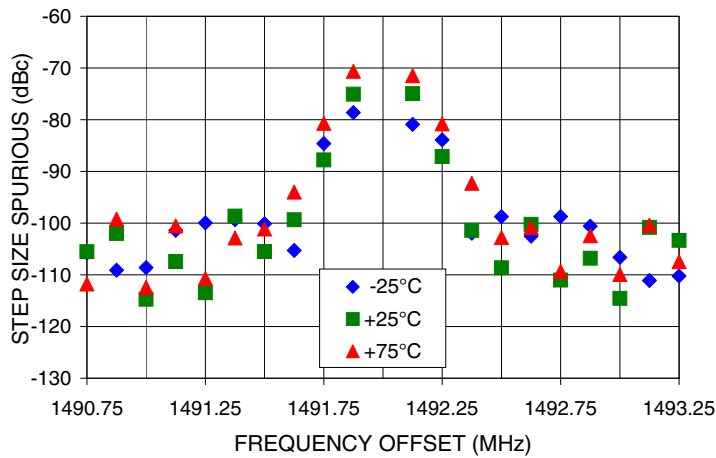

0.5 STEP SIZE & STEP SIZE SPURIOUS
Vs FREQ. OFFSET @ Fcar = 2036MHz

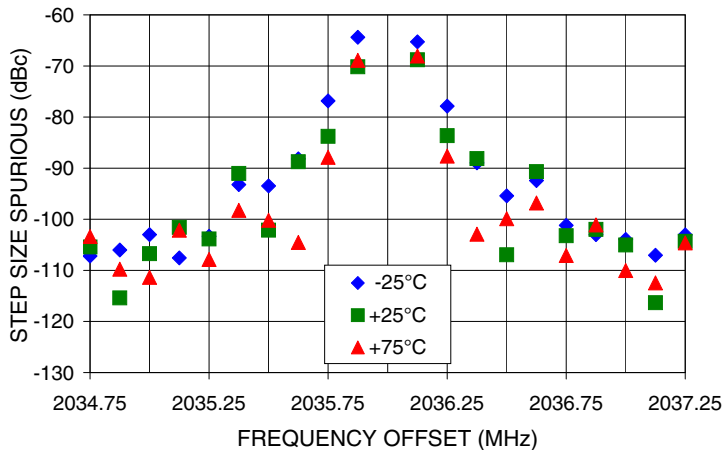

IF/RF MICROWAVE COMPONENTS • ISO 9001 ISO 14001 AS9100 CERTIFIED RoHS compliant
P.O. Box 350166, Brooklyn, New York 11235-0003 (718) 934-4500 Fax (718) 332-4661



The Design Engineers Search Engine finds the model you need, Instantly • For detailed performance specs & shopping online see



Notes: 1. Performance and quality attributes and conditions not expressly stated in this specification sheet are intended to be excluded and do not form a part of this specification sheet. 2. Electrical specifications and performance data contained herein are based on Mini-Circuit's applicable established test performance criteria and measurement instructions. 3. The parts covered by this specification sheet are subject to Mini-Circuits standard limited warranty and terms and conditions (collectively, "Standard Terms"); Purchasers of this part are entitled to the rights and benefits contained therein. For a full statement of the Standard Terms and the exclusive rights and remedies thereunder, please visit Mini-Circuits' website at www.minicircuits.com/MCLStore/terms.jsp.

Pin Configuration

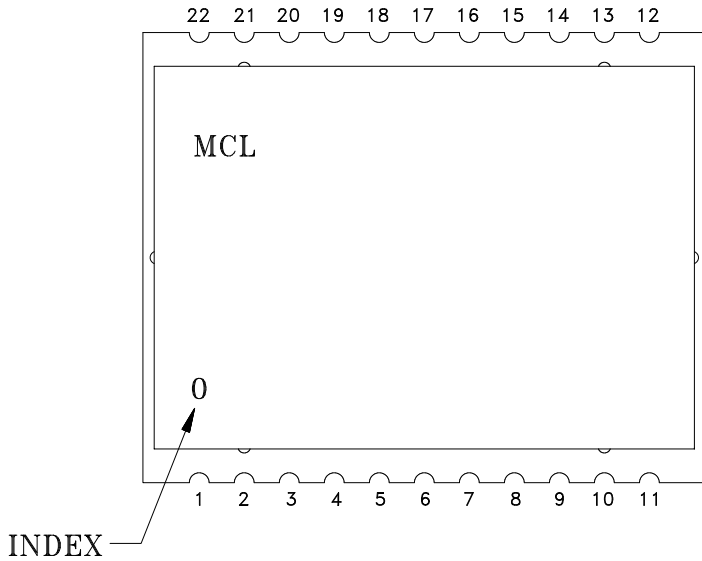

Pin Connection

Pin Number	Function	Pin Number	Function
1	GND	12	LE
2	GND	13	GND
3	GND	14	REF IN
4	GND	15	GND
5	RF OUT	16	VCC VCO
6	GND	17	GND
7	LOCK DET	18	VCC PLL
8	GND	19	GND
9	DATA	20	GND
10	GND	21	GND
11	CLOCK	22	GND

Recommended Application Circuit

Note: REF IN and RF OUT ports are internally AC coupled.

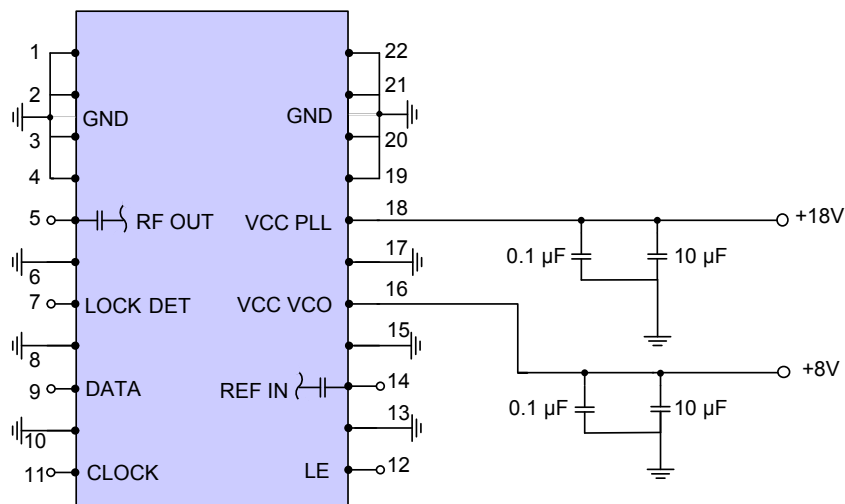

IF/RF MICROWAVE COMPONENTS • ISO 9001 ISO 14001 AS9100 CERTIFIED RoHS compliant
 P.O. Box 350166, Brooklyn, New York 11235-0003 (718) 934-4500 Fax (718) 332-4661



The Design Engineers Search Engine finds the model you need, Instantly • For detailed performance specs & shopping online see

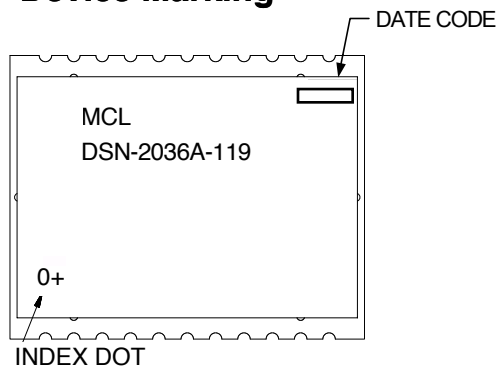

Notes: 1. Performance and quality attributes and conditions not expressly stated in this specification sheet are intended to be excluded and do not form a part of this specification sheet. 2. Electrical specifications and performance data contained herein are based on Mini-Circuit's applicable established test performance criteria and measurement instructions. 3. The parts covered by this specification sheet are subject to Mini-Circuits standard limited warranty and terms and conditions (collectively, "Standard Terms"); Purchasers of this part are entitled to the rights and benefits contained therein. For a full statement of the Standard Terms and the exclusive rights and remedies thereunder, please visit Mini-Circuits' website at www.minicircuits.com/MCLStore/terms.jsp.

Device Marking**Additional Detailed Technical Information**

Additional information is available on our web site. To access this information enter the model number on our web site home page.

Case Style: KL1294

Tape & Reel: TR-F97

Suggested Layout for PCB Design: PL-318

Evaluation Board: TB-553+

Environment Ratings: ENV03T2



IF/RF MICROWAVE COMPONENTS • ISO 9001 ISO 14001 AS9100 CERTIFIED RoHS compliant
P.O. Box 350166, Brooklyn, New York 11235-0003 (718) 934-4500 Fax (718) 332-4661



The Design Engineers Search Engine finds the model you need, Instantly • For detailed performance specs & shopping online see



Notes: 1. Performance and quality attributes and conditions not expressly stated in this specification sheet are intended to be excluded and do not form a part of this specification sheet. 2. Electrical specifications and performance data contained herein are based on Mini-Circuit's applicable established test performance criteria and measurement instructions. 3. The parts covered by this specification sheet are subject to Mini-Circuits standard limited warranty and terms and conditions (collectively, "Standard Terms"); Purchasers of this part are entitled to the rights and benefits contained therein. For a full statement of the Standard Terms and the exclusive rights and remedies thereunder, please visit Mini-Circuits' website at www.minicircuits.com/MCLStore/terms.jsp.